

idea and  
planning guide

A TRENDS SPECIAL  
INTEREST PUBLICATION

TRENDS



*Greetings,*

Thank you for exploring our exciting lineup of Celesta luxury glass enclosures. Each Celesta custom application is proudly handcrafted by Basco, a company whose 50-year legacy of quality craftsmanship has made us the leader in designing and fabricating custom shower door systems.

Transforming your bathroom into the bathroom of your dreams is now easier than ever. This *Idea and Planning Guide* is designed to help you simplify the selection process. Use the images of designer bathrooms to spark your creative energy and imagination. Next, follow the planning pages to select from all the exciting features and possibilities.

Why choose Celesta? When you purchase a Celesta luxury glass enclosure, you can be assured that you will receive:

- A brand name you can trust
- Unparalleled customer service
- A uniquely designed, handcrafted custom enclosure

If you have questions about Celesta, contact your Celesta dealer, or visit us at [www.celestabybasco.com](http://www.celestabybasco.com)

We look forward to serving you and making your dream bathroom a reality.

Sincerely,



*George W. Rohde*

George W. Rohde  
President/CEO





*Pinnacle hinges and a traditional pull in chrome finish set off this swing door. Create this look with Celesta model LX900 swing door.*

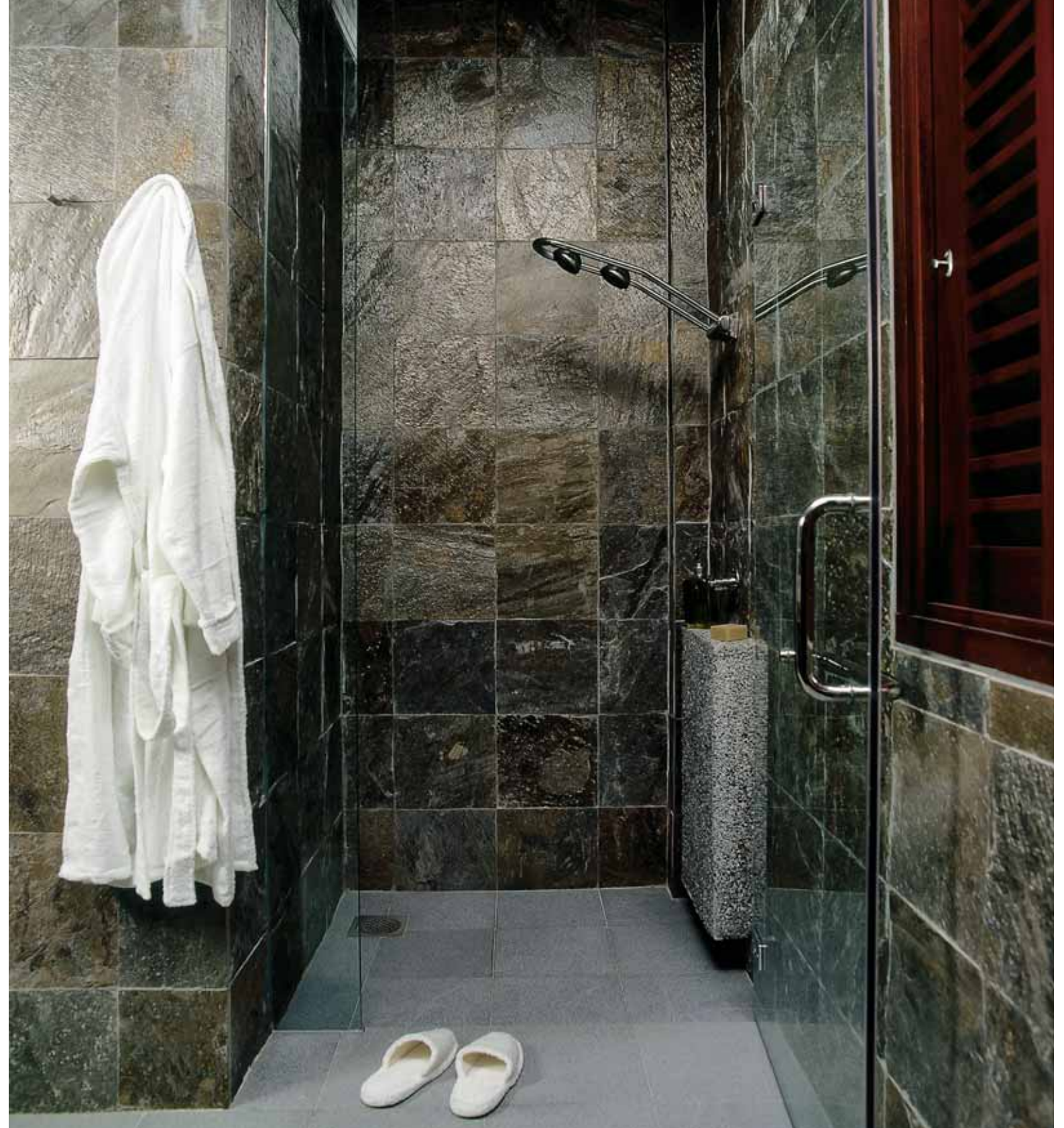

*Traditional pull and towel bar combo and pinnacle hinges in chrome finish and chrome u-channel along the top and bottom. Create this look with Celesta model LX935 door with inline panel.*

"Usually shower surrounds are tiled, and when a frameless glass shower door is used, the tiled surface can be seen and appreciated. It also eliminates the need for a boundary of clunky hardware between the shower and the rest of the space."  
- Reena Racki, Reena Racki Associates, Washington DC.



*Brushed nickel header and u-channel, traditional pull and prima hinges. Create this look with Celesta model LX950 door with notched inline panel and 90° buttress panel.*



*Double swing doors and a stationary window panel are accented with a special order pull and prima hinges in a satin chrome finish. Create this look with Celesta model LX900 double swing door.*

"One of the major advantages of frameless glass shower doors is that they create the illusion that the shower does not have a door at all. This feeling of openness gives the bathroom a nice sense of space."  
- Gail Green, Green and Company, New York.



*Chrome contemporary 2-sided knob, prima hinges and a header and u-channel.  
Create this look with Celesta model LX935 door with inline panel.*



*This contemporary enclosure features chrome-finished Geneva hinges and a traditional pull, and is set in a header and u-channel. Create this look with Celesta model LX950 door with two inline panels and 90° return panel.*

"A frameless glass shower door is an element of the interior design of a bathroom, expressing the continuity of the interior and ensuring the shower is part of the space, rather than forming a separate compartment by itself."  
- Craig Barry, Singer and Associates, Florida.





*A traditional pull and towel bar set and prima hinges finished in satin chrome are featured on this elegant shower. An additional glass panel sits in a u-channel. Create this look with Celesta model LX960 neo-angle with one additional panel.*



*Within a brushed nickel header and u-channel, this shower features a traditional pull and prima hinges. Create this look with Celesta model LX950 door with inline panel and modified angle buttress panel.*

"Frameless glass shower doors offer a neutral aesthetic for the bathroom, whether the style of the space is modern or traditional."

- Kathryn Ogawa, Ogawa/Depardon Architects, New York



*Chrome-finished u-channel, prima hinges and a contemporary 2-sided knob.  
Create this look with Celesta model LX935 door with inline panel.*



*A traditional pull and prima hinges in a chrome finish are featured on this shower enclosure along with a u-channel on the wall and buttress. Create this look with Celesta model LX935 door with inline panel on buttress.*

"Frameless glass shower doors are an element in most bathrooms we design, because of their clean-lined, minimalist appearance."  
- Peter Tow, Tow Studios, New York



*Traditional pull, prima hinges and header and u-channel in brushed nickel finish. Create this look with Celesta model LX950 door with 90° return panel and additional inline panel on buttress.*



*This luxurious enclosure has brushed nickel pinnacle hinges with a u-channel at the top and on the buttresses and a circular pull and towel bar set. Create this look with Celesta model LX960 neo-angle with two additional panels on the buttress.*

"Frameless glass gives a transparency that makes a small bathroom feel larger and allows you to appreciate tiled or stone surfaces."  
- Reena Racki, Reena Racki Associates, Washington DC



*Brushed nickel header and u-channel with prima hinges and a traditional pull.  
Create this look with Celesta model LX925 door with two inline panels.*

Use the following four pages as a guide to help you through the selection process.

## STEP 1 SELECT YOUR CONFIGURATION

Select the configuration that best matches your particular bathroom application. In the event that there is not a configuration that matches your application, consult with your Celesta showroom attendant for a custom design. **Use the grid on the next page to sketch the rough dimensions of your shower opening.**



SWING DOOR  
LX900

Refer to page 3 for example

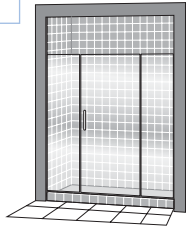

PANEL/DOOR/PANEL  
LX925

Refer to page 15 for example

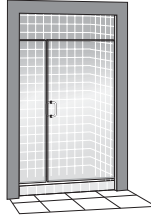

DOOR WITH IN-LINE  
PANEL - LX935

Refer to page 11 for example



DOOR WITH  
90° RETURN - LX945

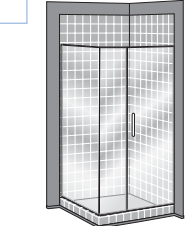

DOOR AND PANEL  
WITH 90° RETURN  
LX950

Refer to page 5 for example

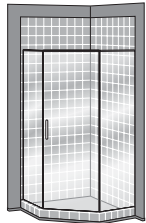

NEO ANGLE  
LX960

Refer to page 14 for example

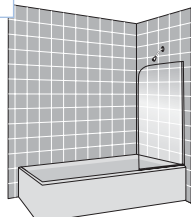

SPLASH PANEL  
LX910

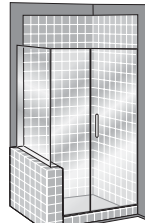

DOOR AND PANEL  
WITH 90° RETURN AND  
NOTCHED PANEL ON  
BUTTRESS LX950

If you don't see the configuration for your bathroom, use the grid on page 19 to sketch your own.

LXNONSTOCK

Check the configuration you prefer

## STEP 2 SELECT YOUR GLASS STYLE

Select the glass style and thickness that best complement your luxury bath design.



CLEAR  
3/8" or 1/2"



ARCTIC FROST  
3/8"

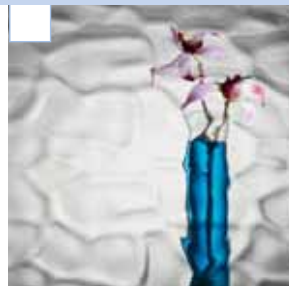

COBBLESTONE  
3/8"

Available glass widths

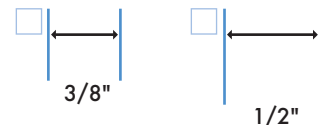

\* 1/4" available upon request

Check the glass style and thickness you prefer

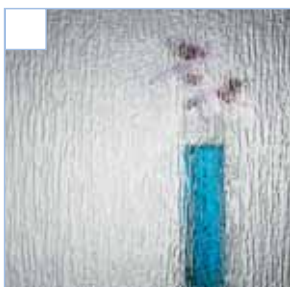

RAIN  
3/8"

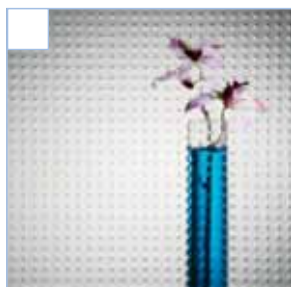

SYMMETRY  
3/8"



VENETIAN  
3/8"



# STEP 3 SELECT YOUR HARDWARE FINISH

Customize the look and feel of your enclosure with your choice of hardware finish.

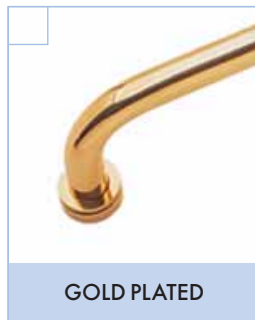
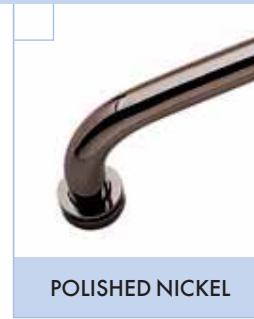
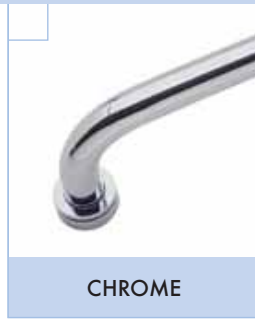

Other available finishes\*: Satin Brass, Brushed Satin Chrome, Antique Brass, White, Almond, Cream, Linen White, Platinum, Satin Nickel, Wrought Iron, Bronze, Burnished Copper, Antique Pewter.

\*Not all hardware options are available in every finish.



Check the hardware finish you desire, or write in one of the other finishes.

\_\_\_\_\_

## NOTE ON HINGE SYSTEMS

Celesta uses high quality, solid brass construction hinges for all luxury glass applications. These hinges provide distinct and secure door operation while being subtle enough to maintain the frameless appearance of the enclosure. Hinge finishes coordinate with handles and towel bars.



The Celesta design department will suggest the hinge system that optimizes frameless style and safe operation.

Hinge systems can include a header which is often paired with a U-Channel. The fixed panel U-Channels secure 3/8" and 1/2" glass to the wall, ceiling or curb and offer a rich accent to heavy glass. Headers and U-Channels are available in the same finishes to match your other hardware.

# STEP 4 SELECT YOUR DOOR HARDWARE STYLE

Enclosures include your choice of either a Door Pull, Door Pull/Towel Bar Set or Knob.

DOOR PULLS



**TRADITIONAL**  
Shown in Polished Nickel



**CIRCULAR**  
Shown in Brass



**ACRYLIC SMOOTH**



**ACRYLIC TWIST**

Door Pulls are constructed of the finest quality tubular brass or acrylic and are available in several different styles. You can choose a circular or traditional pull in one of many finishes available (see Step 2) or you can choose a clear acrylic smooth or twist style. Metal rings on acrylic Door Pulls are available in chrome and brass finishes only.

PULL & TOWEL BAR SETS

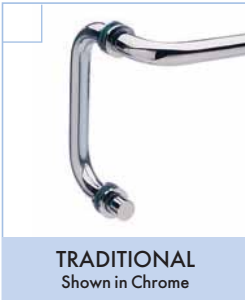

**TRADITIONAL**  
Shown in Chrome



**CIRCULAR**  
Shown in Gold Plated

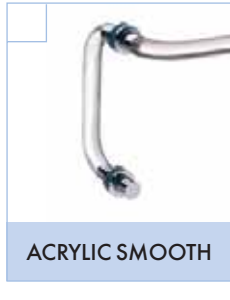

**ACRYLIC SMOOTH**



**ACRYLIC TWIST**

KNOBS



**TRADITIONAL**  
Shown in Chrome



**CONTEMPORARY**  
Shown in Brushed Nickel

Knobs are available in traditional or contemporary styles. Select from back-to-back or single-sided options.

Check the door hardware style you prefer

TOWEL BARS

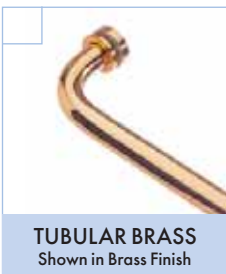

**TUBULAR BRASS**  
Shown in Brass Finish

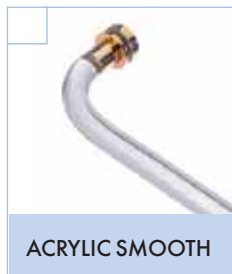

**ACRYLIC SMOOTH**

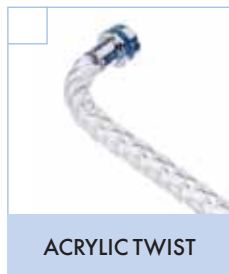

**ACRYLIC TWIST**

Towel Bars are available in 12" (tubular brass only), 18" or 24".

Check if you want an extra towel bar.

## OPTION STEAM APPLICATION

Celesta units can be modified to limit the escape of steam.

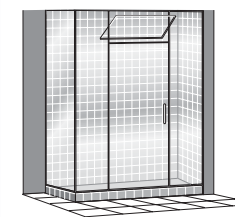

**WITH HINGED TRANSOM**

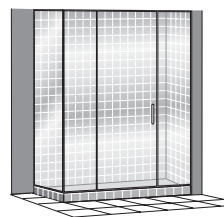

**WITHOUT TRANSOM**

Please specify when requesting a quotation if your preference is to contain steam within your shower. Limit the amount of steam that escapes by designing your Celesta unit floor to ceiling and utilizing a vinyl steam kit.

# OPTION AQUA GLIDE

Have a sparkling clean enclosure without all the scrubbing.



At Basco, we make it possible for your Celesta glass to look luxurious longer. Our AquaGlide™ glass protection system gives your enclosure a protective coating against soap scum, mineral deposits and spotting. With AquaGlide™, cleaning your shower glass is as simple as spraying it with water. At Basco, our team expertly applies this unique seal to your glass before it ever leaves the factory, delivering to you a beautiful and protected enclosure.



Check if you want an AquaGlide glass protection system.

## SKETCH YOUR ROUGH DIMENSIONS

Sketch the rough dimensions of your shower opening. Using the example below as a guide, include height, width, angle of panel(s) and depth of the space for your Celesta glass enclosure. The Celesta design department will use these dimensions to develop a price quote and detailed rendering for you.

For all enclosure specifications and technical details, visit [www.bascoshowerdoor.com](http://www.bascoshowerdoor.com) and click on **Technical Specifications**.

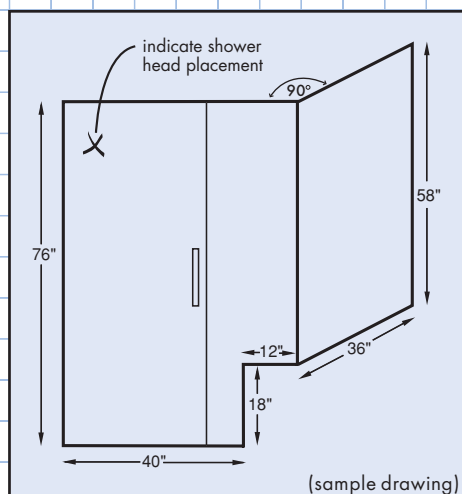

Check if overall height is from floor to ceiling.

